



Solar Access Control with
Camera
For automatic gates
Model ASC

INSTALLATION GUIDE

CellGate
13619 Inwood Rd., Suite 380
Dallas, TX 75244

www.cell-gate.com

Table of Contents

1	INTRODUCTION	3
1.1	Kit Includes	3
1.2	Tools and Materials Needed For Basic Installation	3
1.3	Power	4
2	SYSTEM OVERVIEW	4
3	INSTALLATION PROCEDURES	5
	Locate best camera position:	5
	Electronics enclosure:	5
	Cellular antennas:	7
	Gooseneck/keypad:	7
	Wiring keypad to CellGate electronics:	7
	Gate trigger:	7
	Gate position sensor:	8
	Power:	8
	Cellular connection:	8
	Test access code:	9
	Camera:	9
	At the electronics enclosure:	10
	At the camera:	10
	Adjusting the camera image:	10
	Reviewing the final picture:	11
	Test cameras:	11
3	SYSTEM TEST	12
	Appendix 1 Camera placement options	13
	Camera location option 2:	13
	Camera location option 3:	13
	Appendix 2 Solar charge controller	14
	Appendix 3 Additional camera triggering devices	15
	Motion sensor (PIR)	15
	Photoelectric beam	15
	Exit probe	15
	Trouble Shooting:	16
	Limited Warranty	18
	FCC Requirements	20
	Notes	20

1 INTRODUCTION

The CellGate system is a complete turn-key solution with hardware, web application and cellular service. The hardware included in this package has all the major components needed and is straightforward to install. The following instructions assume that our camera system is included. If only the access control system is used, simply ignore the section that deals with cameras. Additionally it assumes our standard keypad is used. However, the CellGate System can be used with any Wiegand device such as card readers and RFID systems.

1.1 Kit Includes

- ☑ NEMA 3 lockable enclosure that contains all the cellular, access control, power management and picture processing components
- ☑ NEMA 3 lockable battery enclosure (sized for group 24 battery, **battery not included**)
- ☑ Magnetic mount omnidirectional cellular antennas (optional directional antennas are available for locations with low cellular signal strength)
- ☑ Keypad (Wiegand)
- ☑ Solar panel (appropriately sized for application)
- ☑ Solar panel mounting bracket
- ☑ Camera
- ☑ Baluns for connecting camera power and video signal (one pack of two baluns)
- ☑ "Y" power cable for camera adjustment
- ☑ BNC/RCA adapter for camera adjustment

1.2 Tools and Materials Needed For Basic Installation

- ☑ Group 24 deep cycle marine battery
- ☑ 18 gauge, minimum of 4 conductors (recommend stranded and shielded)
- ☑ 12 gauge, two conductor wire for solar panel and battery
- ☑ CAT5 cable for camera, RJ45 connectors and crimping tool
- ☑ Mount for camera (often a double-gang junction box is used)
- ☑ Digital or Analog multi-meter
- ☑ Wire nuts or appropriate terminals/connectors
- ☑ Wire strippers
- ☑ Wire cutters
- ☑ Screws for mounting enclosure
- ☑ Drill
- ☑ Conduit (3/4" recommended)
- ☑ Monitor for aiming, zooming and focusing camera (provided in some kits, check box)

1.3 Power

The CellGate Solar system includes the appropriately sized solar panel and a solar charge controller (battery not included).

NOTE: Be sure to set solar panel to a 45 degree angle and face towards the south.

NOTE: A deep cycle marine battery is recommended. Included in the kit is a steel battery enclosure that is sized for a group 24 battery. Battery is not included.

2 SYSTEM OVERVIEW

Prior to any installation, it is important to plan the location of all the components, where conduits will be run and in particular the content of the picture desired. Figure 1 below is an illustration of a typical installation. This illustration includes dual keypads and dual cameras.

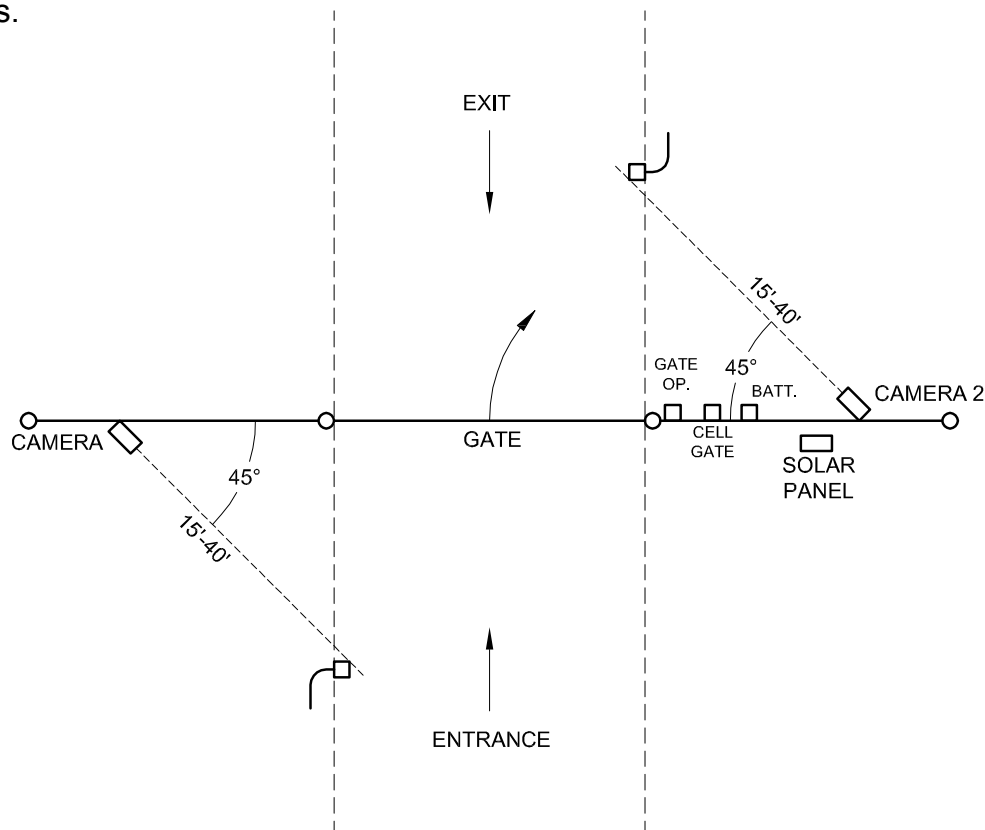

Figure 1- System Overview

3 INSTALLATION PROCEDURES

Locate best camera position:

To minimize the glare of vehicle headlights and provide a front and side view of the vehicle, we recommend that cameras be mounted at **45 degree angle to the keypad** (see Figure 1). Height of the camera mount will vary based on the fencing, trees and security needs of the owner. CAT 5 cable needs to be run from the CellGate electronics to the camera(s) which may also impact the selection of the camera location. The camera has a zoom lens which can accommodate various distances but it is recommended that the camera be **mounted 15'-40' from the keypad**. Once the location of the cameras has been determined, a mounting pole may be required. While any pole can be used, we recommend 4" square steel tubing as this allows the camera to be mounted on the pole, all wiring to be protected inside and this prevents the pole from pivoting when secured in concrete. For additional camera placement options, refer to Appendix 1.

NOTE: Be aware of where the sun rises and sets and avoid placing the camera into the sun!

Set camera poles at the beginning so the concrete can be setting during the rest of the installation process.

Electronics enclosure:

The CellGate electronics are housed in a 12"x15"x6" steel enclosure. The electronics and battery box should be mounted near the gate operator. Refer to Figure 2 for the various components that may be wired to the CellGate electronics enclosure.

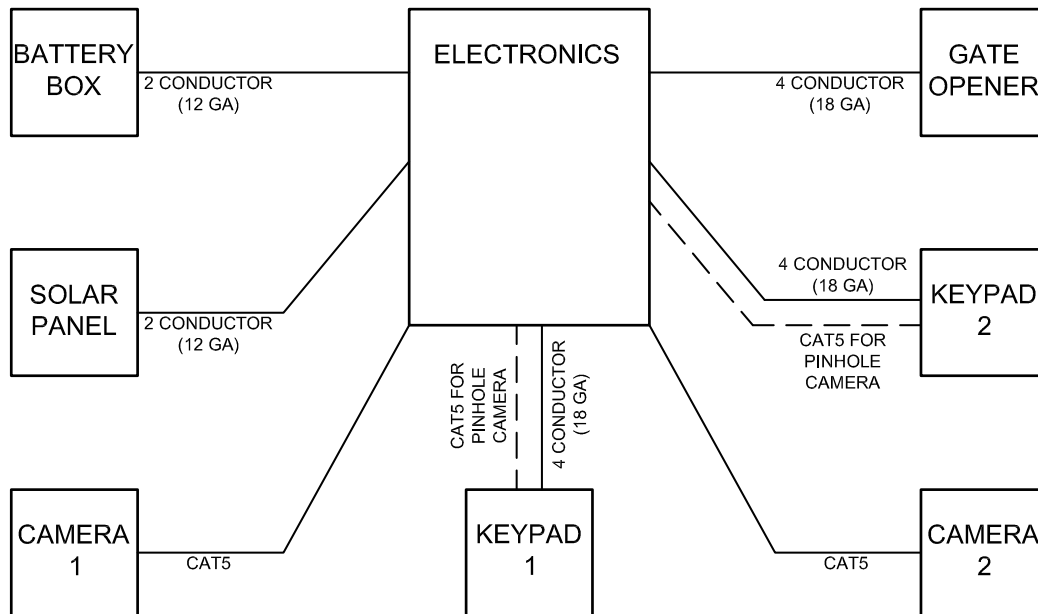

Figure 2 – Electronics Overview

The components in the electronics enclosure are mounted on the inside wall and on two aluminum plates (if there are two cameras, there may be a third plate).

- Top layer: The top layer contains the solar charge controller, a cellular modem and a terminal strip
- Bottom layer: The bottom layer is for the video components including a video server and a cellular modem
- Side panel: Mounted on the inside right of the enclosure is a circuit board called the WIM board. If there is a second keypad, there will also be a WIM expansion board above the WIM.

The internal components are pre wired, so the only wiring connections required are those shown in detail in Figure 3 below.

DO NOT CONNECT POWER UNTIL INSTRUCTED BELOW!

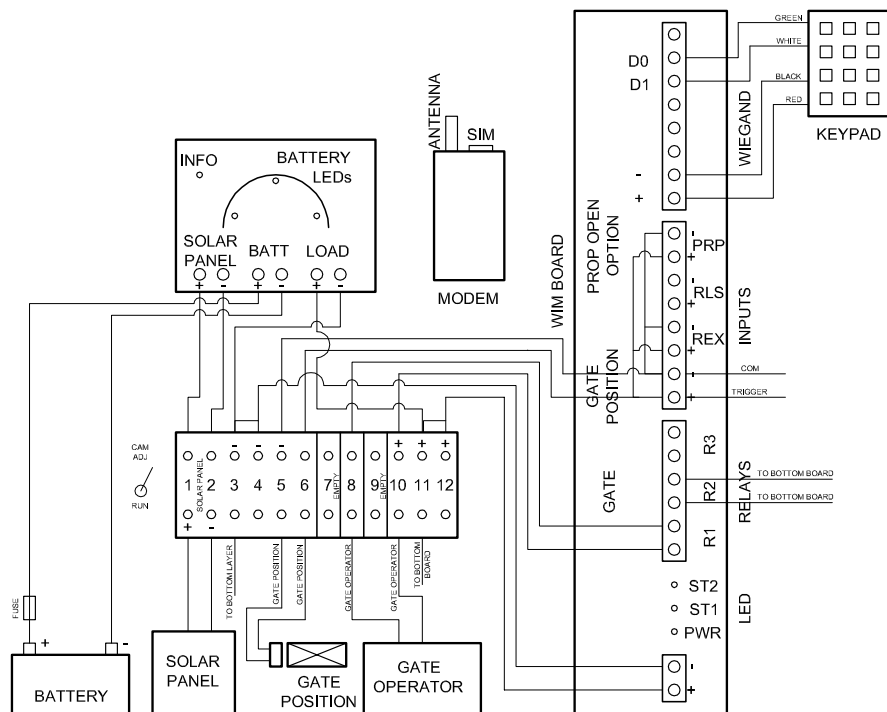

Figure 3 – Top layer wiring diagram

Cellular antennas:

There is a magnetic mount antenna for each layer. These should be run outside of the enclosure and mounted as far apart as possible, and in an a location that is not does not interfere with the signal. Magnetic antennas should point up for best reception. If the AT&T signal strength is very poor, directional antennas may be required.

Gooseneck/keypad:

The CellGate keypad is a Wiegand keypad with access codes created online and stored on the CellGate electronics, not the keypad. Therefore, wires are required from the keypad to the CellGate electronics. A minimum of 4 conductors is required. We recommend 18 gauge, stranded and shielded wire (shielding not required). **CAT 5 CABLE SHOULD NOT BE USED FOR WIRING TO THE KEYPAD.** If there is an existing wired keypad, the existing wires often will work but the wires will terminate in the CellGate electronics enclosure instead of the gate operator.

If an optional pinhole camera is included, CAT 5 will also be required to the keypad. To accommodate the height of trucks and cars, we recommend that the gooseneck be 50” high when a pinhole camera is used.

Mount the keypad provided and connect to the wires inside as follows: red (+), black (-), white (D1) and green (D0). The other wires are not needed. Do the same for the exit keypad if applicable.

Wiring keypad to CellGate electronics:

Attach with wires from the keypad(s) to the WIM board as shown in Figure 3 above. If there are two keypads, wire them as shown in Figure 4 below.

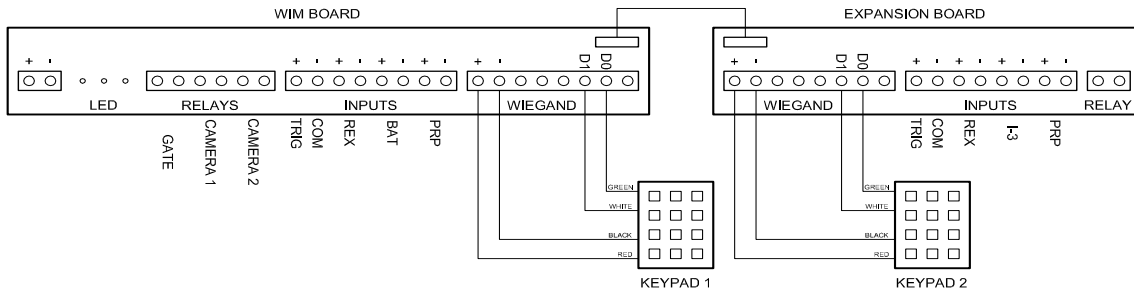

Figure 4 – Dual keypad wiring

Note: the entrance keypad should be wired to the main board and the exit keypad to the expansion board.

Gate trigger:

Relay 1 on the WIM is used to trigger the gate operator. As shown in Figure 3, connect one pair of wires to the screws 8 and 10 on the terminal strip. **Connect these wires to the free exit contacts on the gate operator.** In most CGes, the expansion board has also been preconfigured to trigger relay 1. However, in some CGes it may be

necessary to run a jumper wire from the expansion board relay to relay 1 on the main board in order for the exit keypad to trigger the gate operator.

Gate position sensor:

The CellGate system monitors and reports the status of the gate (open or closed) and will send a prop-open notification if the gate has been left open longer than 3 minutes. Screws 5 and 6 on the terminal strip in Figure 3 are for this purpose. There are three ways to get the gate position: position contacts on the gate operator, closed limit switch on the gate operator or magnetic switches. Using a magnetic switch can result in false open reports due to high wind, slack in the gate and gates that bounce when closed. Therefore when possible, using the gate operator for the gate status is the preferred method.

When connecting to the gate operator board directly, it may be necessary to use a separate relay like an automotive relay to provide sufficient isolation. Also, whether connecting directly to the gate operator board or to a limit switch, it is important to note the polarity. **THE COMMON WIRE MUST BE CONNECTED TO SCREW 5 ON THE TERMINAL BLOCK.**

When using a magnetic switch, the polarity is not an issue. However, care should be taken in the mounting location to minimize the potential for false open notifications.

The WIM is configured for a closed contact when the gate is closed. If the contacts are open when the gate is closed, the configuration can be changed online.

Power:

Connect the battery to the center screws on the solar charge controller as shown in Figure 3. **When using solar power it is important to connect the battery to the solar charger before connecting the solar panel.** Connect the wire to be used for the solar panel (at least 12 gauge recommended) to screws 1 and 2 on the terminal block.

On the solar panel, carefully remove the 4 screws on the junction box. Connect wires to the connectors on the opposite ends of the terminal strip inside the box on the solar panel to get the full voltage from the panel. **Once the wires are connected, be careful as the wires are hot and the solar panel can put out significant current even when facing the ground!**

For more information on the LED states on the solar charge controller, refer to Appendix 2 below.

Cellular connection:

Once the battery is connected, LEDs on the WIM and expansion board will start blinking erratically and quickly. An LED on top of the cellular modem next to the SIM card will

start off solid, then start blinking slowly and steadily. This indicates that the modem is connected to the voice side of the cellular network. This typically takes 1-2 minutes but may take up to 5 minutes or more. If the LED on the modem does not start blinking, directional antennas may be required. Contact CellGate for assistance.

After the LED starts blinking on the modem, the WIM will begin its process of connecting to the data part of the cellular network. This typically takes 1-2 minutes after the LED on the modem starts blinking. When the WIM has connected, the power LED will blink about 1/second. The LED labeled ST1 will blink very briefly and very quickly, then go dark for a few seconds and start blinking again. The number of blinks represents the bars of signal strength. If the LED on the modem is blinking but the power LED on the WIM does not change to a slow, steady blinking pattern, contact CellGate for assistance.

Test access code:

After the WIM has connected to the cellular network, the temporary access code can be tried. The keypad has blue "night lights" that shine down on the keypad and an amber colored LED on the right of the keypad. During the time the WIM is booting up and connecting to the cellular network, the LEDs on the front of the keypad will blink erratically. After cellular connection is established (amber LED on keypad is on solid), enter the temporary access code provided (0 followed by 4 digits). When the first digit is entered, the amber light will go dark and light again after the 5th digit. It may take a few seconds for the code to be accepted at which time relay 1 will trigger, opening the gate. Note: all codes must be 5 digits and it is recommended that they start with a 0 followed by 4 digits.

If there is an exit keypad, repeat the test on it. If the entrance keypad works, but the exit keypad does not, use a wire to connect the first pin on relay 1 on the WIM to the first pin on the relay on the expansion board. Repeat for the second pin on relay 1 to the second pin on the expansion board relay. Test the code again.

If the gate does not open, use an Ohm meter to verify that relay 1 is being triggered when the code is entered. Check the trouble shooting steps below.

Camera:

To make the wiring easier, CAT5 wire is used in conjunction with baluns that convert the video image and power so it can be transmitted over CAT5. The CAT5 needs to be terminated with RJ45 connectors on both ends.

IF COAX CABLE IS USED, USE CRIMP CONNECTORS ONLY. DO NOT USE SCREW ON CONNECTORS!!!

IMPORTANT: It is virtually impossible to adjust the picture image without the use of a video monitor. If you do not have one you can either purchase one at an electronics store or contact CellGate.

The default configuration is for the camera to be triggered when either a valid or invalid code is entered. The camera will not be triggered when a wireless remote (i.e. “clicker”) is used unless wiring changes are made. Other options for triggering the camera include motion sensors or photoelectric beams. For more information about optional camera triggers, refer to Appendix 3.

At the electronics enclosure:

There are two connectors coming out the top of the bottom layer, one for power (2.1mm plug) and one for the video signal (BNC). Plug the power plug into the side of the balun and the BNC connector to the end of the balun. Connect the CAT5 cable from the camera to the balun using an RJ45 connector.

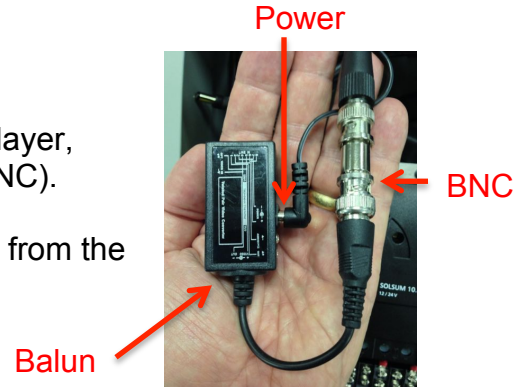

To conserve power, the camera is powered off until a picture is taken. In order to adjust the camera, locate the power switch on the lower left corner of the top plate in the enclosure (to the left of the terminal strip). Turn this switch to the “cam adj” position.



At the camera:

Before permanently mounting the camera, it needs to be adjusted, focused and zoomed to get the image desired. Locate the 2.1mm “Y” power cable and a BNC to RCA adapter (these are both provided and may already be attached to the camera). Using the “Y” cable, attach the power cable to the balun, the camera and a video monitor (included in some CellGate kits). Using the RCA/BNC adapter, attach the BNC to the camera and the RCA side to the yellow RCA plug on the video monitor. If the power switch described above is in the “adj” position, there should be an image on the monitor.

Adjusting the camera image:

Locate the zoom and focus adjustments for the camera (these vary with different camera models so please refer to the instructions with the camera). With the camera located near the mounting position, adjust the zoom, then the focus to get a clear picture. Repeat this process until you have the image you want.

NOTE: A common mistake is to leave the image too wide. The more the camera is zoomed in, the more detail will be available in final picture.

IMPORTANT: Take special care in focusing the image to make it as sharp as possible.

Once the picture is adjusted, remove the monitor with BNC adapter and the Y power cable. Connect the camera power to the side of the balun and the BNC cable from the camera to the balun. Connect the CAT5 cable to the balun using an RJ45 connector. Secure the camera and aim it toward the desired location.

Reviewing the final picture:

Returning to the electronics enclosure, turn the power off by flipping the switch to the “cam on” position. You can view an image from the camera using the monitor used to adjust the camera. The video server has two BNC connectors on the top. The one on the left is connected to the cable that is used for the camera and the one on the right is empty. Using the same BNC/RCA adapter, connect the monitor (yellow connector) to the video server connector on the right, and connect monitor power to a power cable that is free. Turn the power switch back to the “cam adj” position, which will turn on the camera and monitor. You should see the image from the camera. Use this picture for final camera angle adjustment but do not adjust the zoom or focus without having the monitor at the camera. Turn the power switch to the “cam mode” position. The monitor will go dark.

IMPORTANT: WHEN THE CAMERA AJUSTMENT IS COMPLETED, TURN THE POWER SWITH TO THE “CAM MODE” OR “ON” POSITION. IF THIS IS NOT DONE, THE BATTERY WILL RUN OUT OF POWER.

Test cameras:

When a code is entered on the entry keypad, relay 2 on the WIM will close which will trigger the camera and a picture will be transmitted to the CellGate web site. Prior to installation, the system can be configured to send a picture to your cell phone. If this feature has been enabled, you should receive the picture on your phone. Or, you can contact the owner or someone else that has access to the web login to verify the picture was received.

3 SYSTEM TEST

NOTE: Fully testing the installed system may require someone monitoring the web application. In addition, any notifications to email and/or text message need to set up in advance.

Access code/Camera

Enter access code at each keypad: gate should open and picture taken from appropriate camera

If there is more than one camera, verify that the picture is from the correct camera

Confirm the picture is composed correctly and is in focus
If notifications are set up, the access code entered should be sent to the recipient

Enter an invalid code at a keypad. The camera should take a picture.

Open/close notification

When gate opens or closes, a message should be sent to the web application and if notifications are set up, the event(s) should be sent to the recipient.

Hold open notification

Open the gate and hold the gate in the open position by turning off the gate operator or some other means for at least 3 minutes. A prop open notification should be sent to the web application and if notifications are set up, it should be sent to the recipient.

Other camera triggers

If one of the other methods is used to trigger the camera (e.g. photoelectric beam), test this function with “real world” conditions. If it is to be triggered by a moving vehicle, use a moving vehicle to test to verify correct timing, etc.

Nighttime camera testing

If possible, test the camera during the night to confirm impact of headlights.

Appendix 1 Camera placement options

Camera location option 2:

A benefit of the location of the cameras shown in the System Overview is that it provides a view of the front of the vehicle (possibly including the license plate) and the side of the vehicle. Some owners want to see the gate. In this CGe, the camera(s) need to be moved to a location adjacent to the keypad (Figure 4 below). The camera is able to get a view that is approximately 65 degrees wide. This view will show the side of the vehicle (possibly the driver) and the gate. Depending on the layout of the fence, this approach may require the camera to be located outside of the secured area.

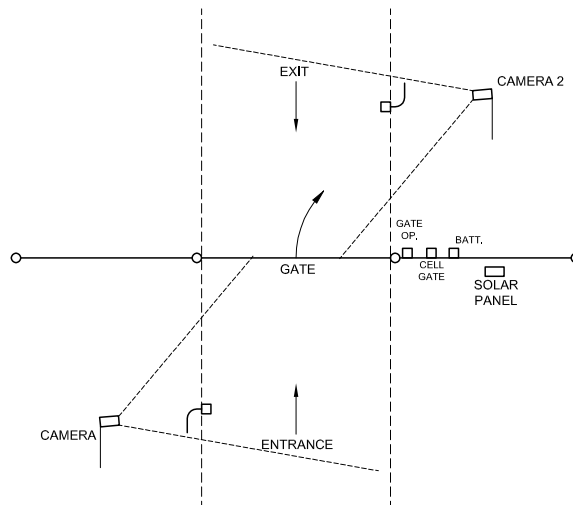

Figure 4 – Camera location option 2

Camera location option 3

Another option that works especially when only 1 camera is used and the gate can be seen through, is to locate the camera on the inside of the gate, aiming it towards the gate. This gives a view of the gate and the vehicle. The clarity of the vehicle depends on the type of gate and where the vehicle stops relative to the gate. This option is shown in Figure 5 below.

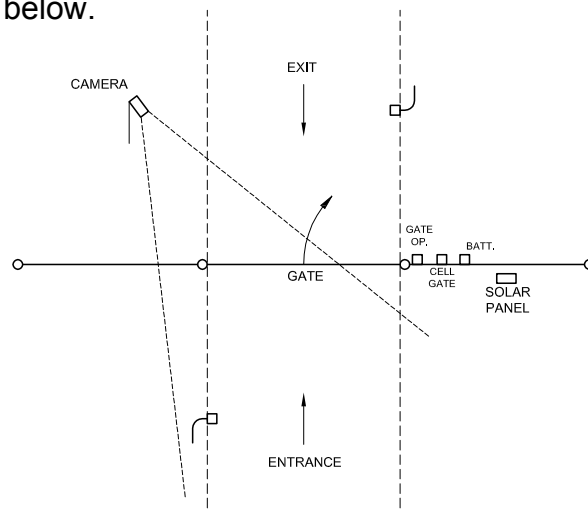

Figure 5 – Camera location option 3

Appendix 2 Solar charge controller

On the solar charge controller, there are two sets of LEDs; the “Info” LED and three LEDs for the battery indicators. The battery indicators are somewhat like a fuel gauge. When operating normally, the Info LED should be on green and the battery LED on the right should either be solid green or blinking. The following table describes the LEDs in detail

LED	Status	Meaning
Info LED	Illuminates green	Normal operation
	Flashes slowly red	System fault <ul style="list-style-type: none"> • Too high charging current • Overload/short circuit Together with red LED: too low battery voltage Together with green LED: too high battery voltage
Battery Red LED	Flashing quickly (3 time in 1 second)	Battery empty, low voltage disconnection prewarning, devices still powered
	Flashing slowly (4 time in 10 seconds)	Deep discharge protection active, power turned off to devices, will return when voltage reaches 12.4v
Battery Yellow LED	Illuminates	Battery weak
	Flashes slowly yellow	Battery has not reached recharge level after cut off described above
Battery Green LED	Illuminates	Battery good
	Flashes quickly	Battery full, solar panel is not charging battery

Appendix 3 Additional camera triggering devices

Using the standard configuration, the camera is triggered when an access code is entered, whether valid or invalid. However, in some CGes where the owner is concerned about people, not just vehicles, or is concerned about multiple vehicles, alternative methods may be used to trigger the camera.

NOTE: IF ONE OF THESE METHODS IS USED TO TRIGGER THE CAMERA, THE RELAY FROM THE DEVICE MUST BE CONNECTED DIRECTLY TO THE INPUT SCREWS 1 AND 2 ON THE CAMERA BOARD. SCREW 2 IS FOR THE COMMON LEG.

Motion sensor (PIR)

As the name implies, a motion sensor detects motion. The detection zone is typically an arc (fan shaped) that can be up to 180 degrees. The detection zone can be masked somewhat to provide a narrower view. The wide area of detection make it very difficult for someone walking up undetected. While this type of device can detect movement within a wide area, it can also be triggered by blowing weeds, leaves, animals or vehicles driving by on the road creating pictures of no value which can be annoying. An additional problem with PIRs is that the precise location of a vehicle is not known which can cause pictures that are blurred by motion or out of focus because of location.

The standard PIRs detect movement up to 50 feet. Additional PIRs are available that detect movement at much greater distances.

Photoelectric beam

These devices use a beam that is transmitted by one device with a reflector bouncing the light back. This beam allows for precise locations of vehicles and can be triggered multiple times by multiple vehicles. Photoelectric devices are effective at ranges up to 40-50 feet. These device are less susceptible to false alarms, but can be triggered by rain and bugs and can also be tampered with. CellGate has special steel enclosures available that protect the device while minimizing false alarms.

Exit probe

These devices sense metal and are great for use if vehicles are the only thing to be monitored. They are buried along side of the drive and can sense multiple vehicles. They typically have ranges of 15 feet (width of drive), but if the drive is wider, one can be used on each side. With exit probes, there are no false alarms as only a vehicle will trigger the camera.

Trouble Shooting:

Reset Button – If the device has been working properly but for no apparent reason is not currently working, press the reset button on the bottom of the electronics enclosure. This will cycle power to the entire system.

PWR LED does not turn on – If the PWR LED does not turn on, power is not connected properly to the device.

PWR LED blinks quickly but never blinks slowly – The wireless unit operates on a GPRS cellular network and this indicates it has not made a data connection. First, make sure the device is in coverage by checking our web site at www.cell-gate.com/coverage. If you are in coverage, check the connection of the antenna and check to see if the LED on the modem is blinking.

Reseat the SIM by using the following steps:

1. Disconnect power.
2. Locate the SIM slot on the modem next to the antenna connector.
3. There is a lock on the corner of the SIM. Slide it away from the SIM. You should feel a slight click.
4. The SIM is spring loaded. If it does not pop up when the lock is moved, press it in slightly and it should pop up. **NOTE: There no need to remove the SIM completely.**
5. Once it has popped up, press it down until it remains down.
6. Slide the lock back over the corner of the SIM.
7. Turn power back on.
8. The LED on the modem will start solid and should start blinking after 30-60 seconds.

If all of these steps have been tried and the device is still not functioning, the specific location might be in a poor coverage area. CellGate at 972-231-1999 for assistance.

The code entered on the keypad does not work

Be sure to enter 5 digits. A temporary code is provided for use during installation testing (0 followed by 4 digits). This code is unique to the device, so be sure to use the code for that specific device.

Power – make sure the LEDs on the keypad are on. If not, then there is no power to the keypad.

Verify cellular connection – The PWR LED on the WIM board should be blinking slowly and steadily.

“valid” Wiegand code – when the first digit is entered, the amber LED will turn off and turn back on after the 5th digit if the code is within the 65000 code limitation of the Wiegand protocol (e.g. the code 66000 is not a valid number even if it is created on the web site).

Test relay – Using an ohm meter, test relay 1 to see if it has continuity when the code is entered. The relay will trigger for 1 second when a valid code is received

Verify correct placement of D0 and D1 wires – If these wires are reversed, the code will not be read correctly. Try reversing the wires and re-entering the code.

The camera does not take a picture

1. Verify that the modem for the camera has power and that there is cellular connection (the LED will be blinking). If the LED is blinking, send a “take picture” command from the web application. On the reports page, the status of the message will show “actuated” when the device receives the command. If after a couple of minutes the message status shows “communication failure”, the modem is not able to communicate with the server.
2. Log in to the web application, then enter an access code at the keypad. On the reports page, there should be a record of the access code that was entered. The next record should be a picture but the possibilities include:
 - a. Good picture
 - b. No record – the camera did not transmit anything.
 - i. Verify the modem has power using step 1 above.
 - ii. If a picture is receive in step 1 above, but not when a code is entered, there is either a problem with the relay on the WIM or wiring from the relay to the camera modem. With an ohm meter, test relays 2 and 3 on the WIM board. There should be continuity when the code is entered. If not, there may be a problem with the relay. If there is continuity, there may be an issue with the wiring from the relay to the camera modem. Contact CellGate technical support for assistance.
 - c. Picture is black or blue – picture is received but it is either all black or all blue. The most common cause of this is the camera not being powered. Turn the switch on that was used to adjust the camera (Cam ADJ position). Take another picture. If the picture is good, with the switch on, then the relay is bad that is powering the camera. Contact CellGate for a replacement.
 - d. Boot report – the next record is from the camera device but it says “boot report”. This is an indicator that the cellular modem is not able to communicate with the video server. Check the Ethernet cables that go into the video server and to the adapter on the top of the modem. There should be a green LED on the video server next to the Ethernet cable. Turn the switch on that was used to adjust the camera (Cam ADJ position). Waite 1 minute and take another picture. If a good picture is received, then the power off and try again. If a boot report is received, there may be a wiring issue. Contact CellGate customer technical support.

If these do not work, contact CellGate technical support at
972-231-1999

E-Mail: support@Cell-Gate.com

Customer service is available free of charge. Hours are 9:00 a.m. to 5:00 p.m. CST. If you call, please have your Device ID number to help our Technicians assist you.

Limited Warranty

Subject to the terms and conditions set forth herein, Gouldin Technologies, LLC, DBA CellGate ("CG") provides this Limited Warranty (the "Warranty"):

- Only to the person or entity that originally purchased the Product from CG or its authorized reseller or distributor; and
- **Only for Products purchased and delivered within the fifty states of the United States.**

Limited Warranty: CG warrants that the hardware portion of the CG Product (the "Hardware" or the "Product") will be free from material defects in workmanship and materials under normal use from the date of original retail purchase of the Product and for one year thereafter ("Limited Warranty Period"), except as otherwise stated herein.

The customer's sole and exclusive remedy and the entire liability of CG and its suppliers under this Limited Warranty will be, at CG's option, to repair or replace the defective Hardware parts during the Limited Warranty Period at no charge to the original owner (though customer may be responsible for labor costs associated with repair of the Product,) or to a refund of the actual purchase price paid. Any repair or replacement will be rendered by CG either at an authorized CG service office or at the customer's location, to be determined by CG in their sole discretion. The replacement hardware need not be new or have an identical make, model or part. CG may, at its option, replace the defective Hardware or any part thereof with any reconditioned product that CG reasonably determines is substantially equivalent (or superior) in all material respects to the defective Hardware. Repaired or replacement hardware will be warranted for the remainder of the original Limited Warranty Period or ninety (90) days, whichever is longer, and is subject to the same limitations and exclusions. If a material defect is incapable of correction, or if CG determines that it is not practical to repair or replace the defective Hardware, the actual price paid by the original purchaser for the defective Hardware will be refunded by CG upon return to CG of the defective Hardware. All Hardware or part thereof that is replaced by CG, or for which the purchase price is refunded, shall become the property of CG upon replacement or refund.

Submitting a Claim: ALL CLAIMS UNDER THIS WARRANTY FOR PRODUCT REPAIR ONLY MUST BE SUBMITTED TO CG IN THE MANNER DESCRIBED BELOW. CUSTOMER RETURNS OR EXCHANGES FOR REASONS NOT COVERED UNDER THIS LIMITED WARRANTY WILL NOT BE ACCEPTED BY CG. SUCH RETURNS OR EXCHANGES MUST BE MADE BY RETURNING THE PRODUCT TO THE ORIGINAL PLACE OF PURCHASE AND WILL BE SUBJECT TO THE RETURN OR EXCHANGE POLICIES OF THE ORIGINAL PLACE OF PURCHASE.

NOTE: A **20% RESTOCKING FEE** WILL APPLY IN THE CASE OF ANY RETURNED PRODUCT NOT COVERED UNDER THIS LIMITED WARRANTY. THE AMOUNT WILL BE DEDUCTED FROM THE ACTUAL PURCHASE PRICE AT THE TIME THE RETURN IS MADE.

SUBMITTING A CLAIM FOR PRODUCT REPAIR:

In order to submit the Product to CG for repairs believed to be covered under the terms of this Warranty, the customer must first contact the CG customer service department at 972-231-1999 for an RMA number for the Product. The customer must then submit with the Product as part of the claim (1) the RMA number, (2) a written description of the Hardware defect in sufficient detail to allow CG to confirm the same, and (3) proof of purchase of the Product (such as a copy of the dated purchase invoice for the Product). The defective Product must be packaged securely in the original or other suitable shipping package to ensure that it will not be damaged in transit.

The customer is responsible for all in-bound shipping charges to CG. No CGh on Delivery ("COD") is allowed. Products sent COD will either be rejected by CG or become the property of CG. Products shall be fully insured by the customer and shipped to **CellGate Systems, Inc. 13619 Inwood Rd., Suite 360 Dallas, TX 75244**. CG will not be held responsible for any packages that are lost in transit to CG. The repaired or replaced packages will be shipped to the customer via UPS Ground or any common carrier selected by CG. Return shipping charges shall be prepaid by CG if you use an address in the United States. Expedited shipping is available upon request and provided shipping charges are prepaid by the customer. CG may reject or return any Product that is not packaged and shipped in strict compliance with

the foregoing requirements. The Product owner agrees to pay CG's reasonable handling and return shipping charges for any Product that is not packaged and shipped in accordance with the foregoing requirements, or that is determined by CG to be an Excluded Product or Repair.

What Is Not Covered: The Limited Warranty provided herein by CG does not cover: Products that, in CG's sole judgment, have been subjected to abuse, accident, alteration, modification, tampering, negligence, misuse, faulty installation, lack of reasonable care, repair or service in any way that is not contemplated in the documentation for the Product, or if the model or serial number has been altered, tampered with, defaced or removed; Initial installation, installation and removal of the Product for repair, and shipping costs; Operational adjustments covered in the operating manual for the Product, and normal maintenance; Damage that occurs in shipment, due to act of God, failures due to power surge, and cosmetic damage; Any hardware, software, firmware or other Products or services provided by anyone other than CG; and Products that have been purchased from inventory clearance or liquidation sales or other sales in which CG, the sellers, or the liquidators expressly disclaim their warranty obligation pertaining to the Product, (collectively, "Excluded Products or Repairs").

If CG finds that the customer's requested Product repairs are Excluded Products or Repairs, CG will notify the customer of their findings and the reasons therefore and will provide the customer an estimate of the cost that will be incurred by the customer to repair the Product. The customer will then have 30 days to respond to CG and to either (1) pay for Product repairs or (2) request that the Product be returned to the customer at the customer's sole expense.

While necessary maintenance or repairs on your Product can be performed by any company, we recommend that you use only an authorized CG service office, as improper or incorrectly performed maintenance or repair voids this Limited Warranty.

Disclaimer of Other Warranties: EXCEPT FOR THE LIMITED WARRANTY SPECIFIED HEREIN, THE PRODUCT IS PROVIDED "AS-IS" WITHOUT ANY WARRANTY OF ANY KIND WHATSOEVER INCLUDING, WITHOUT LIMITATION, ANY WARRANTY OF MERCHANTABILITY, FITNESS FOR A PARTICULAR PURPOSE AND NON-INFRINGEMENT. IF ANY IMPLIED WARRANTY CANNOT BE DISCLAIMED IN ANY TERRITORY WHERE A PRODUCT IS SOLD, THE DURATION OF SUCH IMPLIED WARRANTY SHALL BE LIMITED TO THE DURATION OF THE APPLICABLE LIMITED WARRANTY PERIOD SET FORTH ABOVE. EXCEPT AS EXPRESSLY COVERED UNDER THE LIMITED WARRANTY PROVIDED HEREIN, THE ENTIRE RISK AS TO THE QUALITY, SELECTION AND PERFORMANCE OF THE PRODUCT IS WITH THE PURCHASER OF THE PRODUCT.

Limitation of Liability: TO THE MAXIMUM EXTENT PERMITTED BY LAW, CG IS NOT LIABLE UNDER ANY CONTRACT, NEGLIGENCE, STRICT LIABILITY OR OTHER LEGAL OR EQUITABLE THEORY FOR ANY LOSS OF USE OF THE PRODUCT, INCONVENIENCE OR DAMAGES OF ANY CHARACTER, WHETHER DIRECT, SPECIAL, INCIDENTAL OR CONSEQUENTIAL (INCLUDING, BUT NOT LIMITED TO, DAMAGES FOR LOSS OF GOODWILL, LOSS OF REVENUE OR PROFIT, WORK STOPPAGE, COMPUTER FAILURE OR MALFUNCTION, FAILURE OF OTHER EQUIPMENT OR COMPUTER PROGRAMS TO WHICH CG'S PRODUCT IS CONNECTED WITH, LOSS OF INFORMATION OR DATA CONTAINED IN, STORED ON, OR INTEGRATED WITH ANY PRODUCT RETURNED TO CG FOR LIMITED WARRANTY SERVICE) RESULTING FROM THE USE OF THE PRODUCT, RELATING TO LIMITED WARRANTY SERVICE, OR ARISING OUT OF ANY BREACH OF THIS LIMITED WARRANTY, EVEN IF CG HAS BEEN ADVISED OF THE POSSIBILITY OF SUCH DAMAGES. THE SOLE REMEDY FOR A BREACH OF THE FOREGOING LIMITED WARRANTY IS REPAIR, REPLACEMENT OR REFUND OF THE DEFECTIVE OR NON-CONFORMING PRODUCT. THE MAXIMUM LIABILITY OF CG UNDER THIS LIMITED WARRANTY IS LIMITED TO THE PURCHASE PRICE OF THE PRODUCT COVERED BY THE LIMITED WARRANTY. THE FOREGOING EXPRESS WRITTEN WARRANTIES AND REMEDIES ARE EXCLUSIVE AND ARE IN LIEU OF ANY OTHER WARRANTIES OR REMEDIES, EXPRESS, IMPLIED OR STATUTORY.

Governing Law: This Limited Warranty shall be governed by the laws of the Texas.

FCC Requirements

1. THE STANDARD SYSTEM IS DESIGNED ONLY AS A WIRELESS SYSTEM. DO NOT CONNECT TO WIRED TELEPHONE SYSTEMS INCLUDING IN-BULDING EQUIPMENT OR TELEPHONE COMPANY SYSTEMS. IT HAS NOT BEEN CERTIFIED AS COMPLIANT WITH PART 68 OF THE FEDERAL COMMUNICATIONS COMMISSION RULES.

2. The cellular modem is certified by the FCC, PTCRB and carriers.

Notes

Use this space to keep a record of Access Codes and the MASTER Code
